

Installation and Operation Manual

BDM-600x Microinverter





(888) 598-9901
info@northernep.com
www.northernep.com

Contents:



COMPANY PROFILE	4
1. INTRODUCTION	5
1.1 Prefix	5
1.2 Standards Compliance	5
1.3 How to Use This Manual	5
1.4 Label	5
2. SAFETY INSTRUCTION	6
3. FCC COMPLIANCE	7
4. INSTALLATION	8
4.1 NEP Parts Needed	8
4.2 Additional Parts and Tools Required	8
4.3 Lightning Surge Suppression	8
4.4 Installation Procedure	9
4.5 Install the AC Branch Circuit Junction Box	10
4.6 Attach BDM-600x to the Racking	11
4.7 Connect the BDM-600x Wiring Harnesses	11
4.8 Ground the System	12
4.8A Through Trunk Cable	12
4.8.B Through Racking	12
5. Commissioning	13
5.1 Commissioning Steps	13
5.2 Inverter/RSD Serial Input	13
5.2.A Manually on Device	13
5.2.B Using USB Barcode Scanner	14
5.2.C Using Web Browser	14
5.3 Installer Registration	15
5.4 Homeowner Registration	15
5.5 Pre-Commissioning Setup	15
5.6 Create a Site on NEP Website	16
5.7 Verify and Map Site	17
5.8 Commission the Gateway and Confirm Site Setup	17
5.9 Grant Homeowner Access to Module View (Optional)	18
6. Operating Instructions	18
6.1 Status: Standby	18
6.2 Producing Power	18
6.3 Grounding Fault	18



(888) 598-9901
info@northernep.com
www.northernep.com

7. TROUBLESHOOTING AND MAINTENANCE-----	19
7.1 LED Indication of Error-----	19
7.1.C Error Mode (except for grounding error)-----	19
7.1.B NOT communicating with BDG-256. and with no error-----	19
7.1.C Grounding Fault-----	19
7.2 Troubleshooting An Inoperable BDM-600x/400-----	19
7.3 Disconnecting a BDM-600x from the PV Module-----	20
7.4 Installing a Replacement BDM-600x-----	20
8. Data Sheets-----	21
9. WARRANTY AND PRODUCTION INFORMATION-----	22
What does this warranty cover and how long does it last?-----	22
What will NEP do?-----	22
How do you get service?-----	22
What does this warranty not cover?-----	23
Disclaimer Product-----	23



 (888) 598-9901
 info@northernep.com
 www.northernep.com

COMPANY PROFILE

Northern Electric Power Technology Inc. (NEP) is a U.S.-based company with manufacturing and R&D facilities in Asia. Our mission is to develop cutting-edge clean energy technologies and provide state-of-the-art solar inverter, rapid shutdown, and monitoring products to our customers.

Our headquarters are located in Tsingtao, a major industrial center and trading port in northeastern China. Our campus occupies over 18 acres in the Tsingtao Export Processing Zone, with more than 650,000 square feet of building space. We plan to connect our campus through a micro smart grid demo community, powered by solar, wind, and micro turbines. In addition to our headquarters, we have operation offices Pleasonton, USA.

Our founders are well-known experts in the fields of power electronics, automatic control, signal processing, and communications. Each of our founders has multiple U.S. and world patents in their specialty areas, and received Ph.D. degrees from top universities in North America. They each have over 10 years of engineering and management experience in leading U.S. companies.

NEP offers a complete product line of grid-tied solar inverters, including micro inverters ranging from 180W to 2000W, and industry leading Rapid Shutdown Devices (RSD). Our field deployment results have demonstrated the high efficiency and reliability of NEP solar inverters.

At NEP, we are committed to developing Clean, Reliable, Affordable, and Efficient products for our customers worldwide.

1. INTRODUCTION

1.1 Prefix

We hope that our products will meet your needs for renewable energy. We highly value your feedback regarding our products and would greatly appreciate any comments you may have.

Thank you for your business, and please do not hesitate to contact us if you have any questions or concerns.

1.2 Standards Compliance

The ----- complies with the NEC 2014 and NEC 2017 article 690.12, and CEC 2015 section 64-218.







1.3 How to Use This Manual

This manual provides detailed product information and installation instructions for the ----- . Please read through this manual before installation and operation.





WARNING: This indicates a situation where failure to follow instructions may be a safety hazard or cause equipment malfunction. Use extreme caution and follow instructions carefully.

1.4 Label

	Danger! The term “danger” describes an issue which, if ignored can <u>cause</u> personal injury.
	Attention! With the term “attention” a circumstance is listed which may cause property damage if disregarded.
	Instructions for use! Under “Instructions for <u>Use</u> ”, it is pointed out that installation and operating instructions are to be read and understood before installation or repair.
	Caution, hot surface! Under “Caution, hot surface”, it should be noted that surfaces of equipment may be hot and create a burn hazard.
	Special disposal instructions! With “Note Separate Disposal”, it is pointed out that this product may not be disposed of with normal garbage. An improperly conducted disposal can lead to damage to the environment.
	CE mark The product complies with essential requirements of <u>relevant</u> directives of EU.



 (888) 598-9901
 info@northernep.com
 www.northernep.com

2. SAFETY INSTRUCTION



WARNING:

PLEASE READ THIS MANUAL BEFORE INSTALLATION. ANY DAMAGE TO THE PRODUCT

DUE TO NOT FOLLOWING THIS MANUAL IS NOT COVERED BY THE WARRANTY. ALL THE INSTALLATION SHOULD BE DONE BY CERTIFIED ELECTRICIAN.

IT IS IMPORTANT TO NOTE THAT NOTHING INSIDE THE PRODUCT SHOULD BE MODIFIED, ASIDE FROM THE CABLE CONNECTORS. ANY MODIFICATION TO THE INTERNAL COMPONENTS OF THE PRODUCT MAY RESULT IN MALFUNCTION OR DAMAGE, AND MAY ALSO VOID THE PRODUCT'S WARRANTY.

ALL INSTALLATION SHOULD FOLLOW THE LOCAL ELECTRIC CODES.



WARNING:



WHEN THE PHOTOVOLTAIC ARRAY IS EXPOSED TO LIGHT, IT SUPPLIES A DC VOLTAGE TO THE PVGRSD



WARNING:

THIS PHOTOVOLTAIC RAPID SHUTDOWN EQUIPMENT (PVRSE) DOES NOT PERFORM ALL OF THE FUNCTIONS OF A COMPLETE PHOTOVOLTAIC RAPID SHUTDOWN SYSTEM (PVRSS). THIS PVRSE MUST BE INSTALLED WITH OTHER EQUIPMENT TO FORM A COMPLETE PVRSS THAT MEETS THE REQUIREMENTS OF NEC (NFPA 70) SECTION 690.12 FOR CONTROLLED CONDUCTORS OUTSIDE THE ARRAY. OTHER EQUIPMENT INSTALLED IN OR ON THIS PV SYSTEM MAY ADVERSELY AFFECT THE OPERATION OF THE PVRSS. IT IS THE RESPONSIBILITY OF THE INSTALLER TO ENSURE THAT THE COMPLETED PV SYSTEM MEETS THE RAPID SHUTDOWN FUNCTIONAL REQUIREMENTS. THIS EQUIPMENT MUST BE INSTALLED ACCORDING TO THE MANUFACTURER'S INSTALLATION INSTRUCTIONS.



 (888) 598-9901
 info@northernep.com
 www.northernep.com

3. FCC COMPLIANCE

This equipment has been tested and found to comply with the limits for a Class B digital device, pursuant to part 15 of the FCC Rules. These limits are designed to provide reasonable protection against harmful interference in a residential installation. This equipment generates uses and can radiate radio frequency energy and, if not installed and used in accordance with the instructions, may cause harmful interference to radio communications. However, there is no guarantee that interference will not occur in a particular installation. If this equipment does cause harmful interference to radio or television reception, which can be determined by turning the equipment off and on, the user is encouraged to try to correct the interference by one or more of the following measures:

- Reorient or relocate the receiving antenna.
- Increase the separation between the equipment and the receiver.
- Connect the equipment into an outlet on a circuit different from that to which the receiver is connected.
- Consult the dealer or an experienced radio/TV technician for help.

Changes or modifications not expressly approved by the party responsible for compliance may void the user's authority to operate the equipment.

4. INSTALLATION



Please be aware that the installation of this equipment carries the risk of electric shock. Conductors that are typically grounded may become ungrounded and energized when a ground fault is detected.

4.1 NEP Parts Needed

In addition to the micro inverters, PV modules, racking, and associated hardware, you'll need the BDM-600x installation kit. This kit includes the following items:

- AC trunk cable (one per micro)
- Protective end cap (one per branch circuit)
- Tail cable (one per branch circuit- 16' long)
- Male connector (optional) Used to make extension cables
- BDG-256 (or BDG-256P3 for 3 phase)

The BDM-600 Ships six (6) to a box with each box measuring approximately 18" x 13.5" x 16" and weighing 57 lbs. A typical pallet contains 27 boxes.

4.2 Additional Parts and Tools Required

In addition to the PV modules, racking, and associated hardware, you'll need the following parts:

- MLPE rail or frame attach clamps (2 per microinverter)
- AC junction boxes (multiple options possible)
- Cordgrip with locknut or strain relief fitting (one per branch circuit)
- A subpanel may be required for systems with multiple branch circuits
- Cable clips
- Sockets, wrenches, torque wrench, multimeter, small flat head screwdriver, and mirror with extension rod
- Lightning and surge suppressor (recommended)

4.3 Lightning Surge Suppression

- It's important to note that lightning strikes can cause damage to PV systems even without directly hitting the equipment or building where the system is installed. The electrical grid can experience voltage spikes induced by a nearby lightning strike, which can in turn damage the equipment. While the BDM-600x includes integrated surge protection that is greater than that found in most string inverters, it is still possible for the protection to be exceeded if the surge has sufficient energy, resulting in damage to the equipment.
- Because the NEP Limited Warranty does not cover "acts of God" such as lightning strikes, and given that these strikes can occur anywhere, it is recommended to install surge protection as part of any solar installation. Any surge protection devices should be installed in accordance with the vendor's instructions

4.4 Installation Procedure



WARNING: : DO NOT CONNECT BDM-600x TO THE UTILITY GRID OR ENERGIZE THE AC CIRCUIT(S) UNTIL YOU HAVE COMPLETED ALL OF THE INSTALLATION PROCEDURES AS DESCRIBED IN THE FOLLOWING SECTIONS.

Installing the BDM-600x Micro inverter System involves several key steps:

- Measuring service and installing the AC branch circuit junction box.



WARNING: ONLY USE ELECTRICAL SYSTEM COMPONENTS APPROVED FOR WET LOCATIONS

- Attaching the BDM-600x Micro inverter to the racking.
- Connecting the BDM-600x Micro inverter daisy chain connections
- .Grounding the system (optional)¹
- Completing the BDM-600x Micro inverter installation map and connecting the PV modules.

The finished system should be similar as in the diagram. Detailed installation steps are listed in the following section.

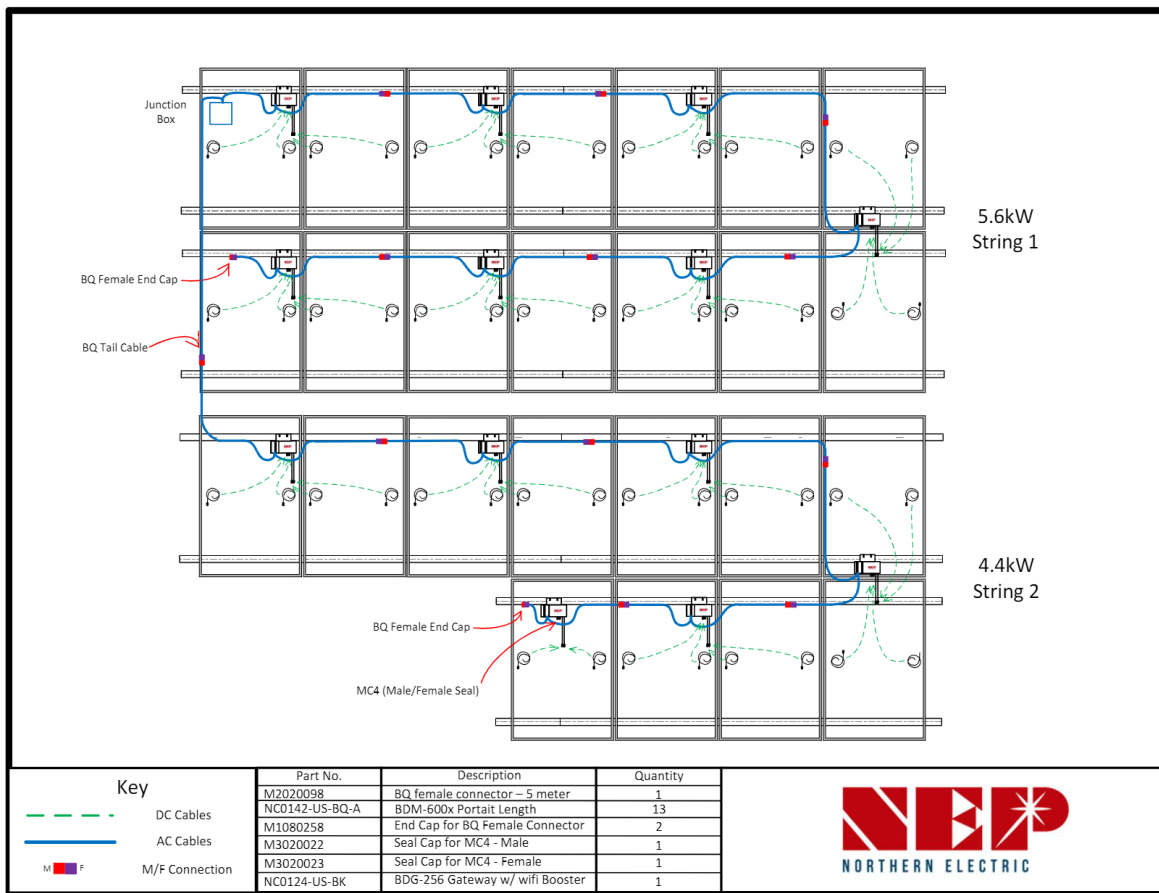

¹DC circuits of BDM-600x are isolated and insulated from ground. An integrated grounding protection circuit is included in the micro inverter.

4.5 Install the AC Branch Circuit Junction Box

- Measure service entrance conductors to confirm AC service at the site. Acceptable ranges are shown in the table below:

1. BDM-600x-240A & BDM-600x-208A (North America)

240 Volt AC Single Phase		208 Volt AC Single Phase	
L1 to L2	211 to 264 Vac	L1 to L2	183 to 229 Vac

2. BDM-600x-AU (Australia and New Zealand)

L1 to L2	230 Vac
----------	---------

3. BDM-600x-EU (Europe)

L1 to L2	230 Vac
----------	---------

- Mount the adapter plate onto the PV racking system at a suitable location, usually at the end of a row of modules.
- Install a junction box with the adapter plate that is compatible with the microinverter.
- Connect the open wire end of the AC interconnect cable to the junction box using a gland or strain relief fitting that is appropriate for the cable. It is important to use a strain relief connector with a diameter opening of 3/8 inches for the AC interconnect cable.

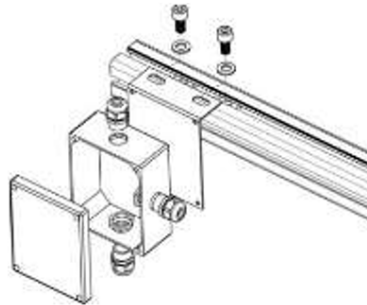

4.6 Attach BDM-600x to the Racking

- Mark the approximate center points between your modules as a mark for where to mount your microinverters.



WARNING: ALLOW A MINIMUM OF 2.75 INCHES BETWEEN THE TOP OF THE ROOF AND THE BOTTOM OF BDM-600x. WE ALSO RECOMMEND THAT YOU ALLOW .50 INCHES BETWEEN THE BACK OF THE PV MODULE AND THE TOP OF BDM-600x. DO NOT MOUNT BDM-600x IN A LOCATION THAT ALLOWS LONG-TERM EXPOSURE TO DIRECT SUNLIGHT.

- Mount one microinverter at each of these locations using the hardware recommended by the module racking vendor. Attach the microinverter to the racking system or the adapter plate using the provided mounting holes. Ensure that the microinverter is securely fastened and level.

4.7 Connect the BDM-600x Wiring Harnesses

- Each BDM-600x comes with an integrated trunk cable to simplify the AC connection process. The AC trunk cable includes a male connector on one end and a female connector at the other end. Plug the male AC connector of the first BDM-600 into the connector on the tail cable. Plug the female AC connector of the first BDM-600x into the male connector of the next BDM-600x (or jumper cable) and continue this “daisy chain” process to form a continuous AC branch circuit. Terminate the final female connector on the last microinverter in the branch circuit with the protective cap. A “click” indicates proper mating. Secure the mated connector pairs and any excess AC cable to the rail or racking using cable clips or wire ties

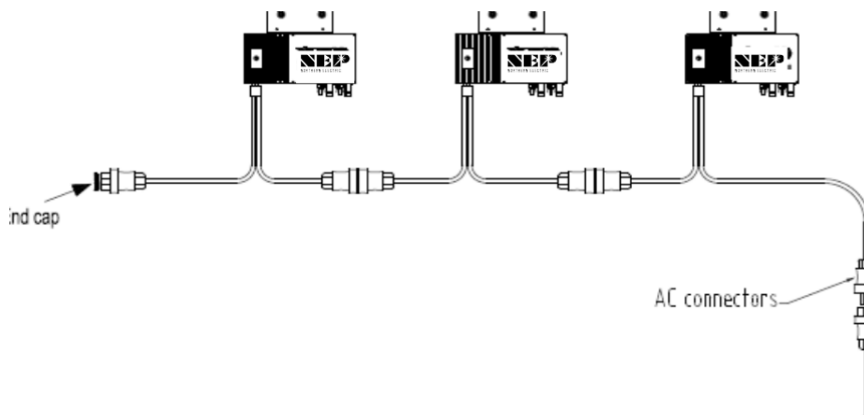



(888) 598-9901
info@northernep.com
www.northernep.com



WARNING: DO NOT EXCEED THE MAXIMUM NUMBER OF BDM-600x IN AN AC BRANCH CIRCUIT, AS DISPLAYED ON THE UNIT-RATING LABEL. For 12AWG trunk cable, EACH BDM-600x AC BRANCH CIRCUIT MUST BE SOURCED FROM A DEDICATED BRANCH CIRCUIT PROTECTED BY A 20A MAXIMUM BREAKER..



WARNING: MAKE SURE PROTECTIVE END CAPS HAVE BEEN INSTALLED ON ALL UNUSED AC CONNECTORS. UNUSED AC BDM-600x WIRE HARNESS CONNECTORS ARE LIVE WHEN THE SYSTEM IS ENERGIZED BY THE UTILITY SYSTEM.

- Install a protective end cap on the open AC connector at the end of the truck cable

4.8 Ground the System

4.8A Through Trunk Cable

- Each BDM-600x has a built-in ground protection circuit. The grounding wire is connected through the trunk cable and should be securely attached to the ground connector in the junction box to ensure proper grounding of the microinverters. It is important to follow all local electrical codes and regulations.

4.8.B Through Racking

- BDM-600x may also be grounded through the racking as shown below.

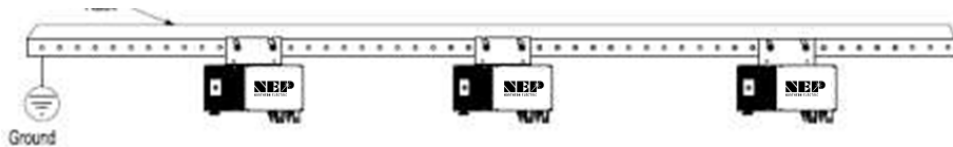

5. Commissioning



WARNING: CONNECT BDM-600x TO THE ELECTRICAL UTILITY GRID ONLY AFTER RECEIVING PRIOR APPROVAL FROM THE UTILITY COMPANY.



WARNING: BE AWARE THAT ONLY QUALIFIED PERSONNEL CAN CONNECT BDM-600x TO THE ELECTRICAL UTILITY GRID.



WARNING: ENSURE THAT ALL AC AND DC WIRING IS CORRECT. ENSURE THAT NONE OF THE AC AND DC WIRES IS PINCHED OR DAMAGED. ENSURE THAT ALL JUNCTION BOXES ARE PROPERLY CLOSED.

5.1 Commissioning Steps

- Switch on the AC disconnects or circuit breakers of each BDM-600x AC branch circuit.
- Activate the main utility-grid AC circuit breaker to initiate power production. Please allow for a few minutes of wait time.
- The BDM-600x will begin transmitting performance data through power line communication (PLC) to the BDG-256. The duration for each BDM-600x in the system to communicate with the BDG-256 will vary depending on the number of BDM-600xs installed.

5.2 Inverter/RSD Serial Input

To ensure a successful serial input process, it is essential to have a comprehensive site map that outlines the sequence of serial number input. It is crucial to keep in mind that the module that is connected to the longer DC connection on the inverter will end with the number 1, while the module connected to the shorter DC connection will end with the number 0.

5.2.A Manually on Device

- One method of inputting serial numbers is manually with the provided stylus directly into the gateway. Although this method may be difficult for larger PV arrays, it can be a simple solution for small arrays. To input serial numbers, navigate to Setting → COM ID on the gateway, where a list of empty cells and inverter numbers will be displayed on the left side.
- To input serial numbers, locate the values between the dashes from the list of serials on your site map. For example: 21508-0005F130-U. It's important to note which serial corresponds to each inverter/module number on your site map for easier input later into the web portal. Once the serial number is inputted and saved, the gateway will prompt a reboot.

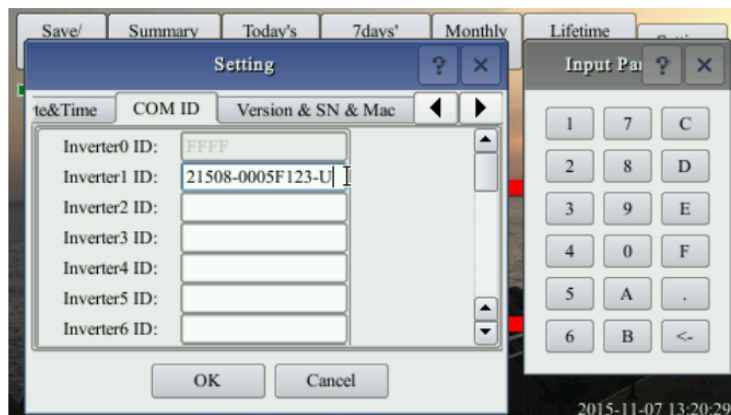

5.2.B Using USB Barcode Scanner

- NEP offers a barcode scanner that can simplify the process of inputting serial numbers. To use the scanner, plug it into the gateway's USB port and navigate to the COM ID screen as in section 6.1.A. Scan the barcode of the desired module into the Inverter1 cell, and repeat until all serial numbers have been input. Make sure to note which module corresponds to each serial number for easier identification later on. Once all serials have been input, the gateway will prompt for a reboot.



5.2.C Using Web Browser

- Another option for serial input is through a web browser. This method requires the gateway to be assigned an IP address and connected to WiFi. To begin, access the web browser on your device (such as a phone or laptop) and enter the gateway's IP address followed by "/module" (e.g. <http://192.168.99.1/module>)
- Once on the module input screen, you can easily input the serial numbers using your keyboard. After inputting all the necessary serial numbers, remember to reboot the gateway to ensure the changes are applied. To do this, simply remove the power source and plug it back in. Finally, return to the module input screen on the gateway to confirm that all the serial numbers were successfully entered.

Inverter COM-ID Administration

e.g. 21508-0005F123-U, input the whole string or '0005F123' or '5F123'

Inverter1:	<input type="text" value="30000020"/>
Inverter2:	<input type="text" value="3000AFE0"/>
Inverter3:	<input type="text" value="30032EE0"/>
Inverter4:	<input type="text" value="00000534"/>
Inverter5:	<input type="text" value="3003AB00"/>
Inverter6:	<input type="text" value="3003AB01"/>



(888) 598-9901
info@northernep.com
www.northernep.com

5.3 Installer Registration

- If you are new to using NEP products, please visit our registration page at https://user.nepviewer.com/pv_manager/register.php?lang=en to create an account for yourself or your company. We recommend providing as much detail as possible to help us better understand your needs.
- Once you have registered, please contact NEP Support via email at support@northernep.com or by calling (888) 598-9901 to have your account upgraded to an installer account. This will allow you to access additional features and resources to help you better manage your NEP products.

User Registration

A screenshot of a web-based user registration form. The form is titled 'Please fill in the following information' and contains several input fields: Email, Password, Confirm Password, Street, City, Country (a dropdown menu with 'select' visible), State / Province (a dropdown menu with 'select' visible), Zip Code, Contact Person, and Contact Number. A blue 'Done' button is located at the bottom left of the form.

5.4 Homeowner Registration

- To start using NEP products, homeowners can register for an account by visiting https://user.nepviewer.com/pv_manager/register.php?lang=en. Once they have created their account, they can begin to enjoy the benefits of NEP's solar products.

5.5 Pre-Commissioning Setup

- Begin by connecting the BDG-256 gateway to the internet using one of the three methods outlined in the "BDG-256 Quick Installation Guide."
- Once connected, enter the serial numbers of the inverters using one of the three methods described in the same guide.

Note: It is recommended to complete steps 3.1 and 3.2 in a warehouse or homeowner's garage using a standard 120V outlet before installing the gateway onto the home's 240V wiring. Only perform Step 6.4b prior to arriving at the job site if using the NEP range extender.



(888) 598-9901
info@northernep.com
www.northernep.com

5.6 Create a Site on NEP Website

- Access your installer account on the NEP website at https://user.nepviewer.com/pv_manager/login.php using your registered email and log in to your account. Then, click on the "Add Site" button to create a new site.
- Fill out all the necessary fields in the site creator, including the serial number of the gateway, which can be found on the top-left of the gateway bezel or by navigating to Menu > Software on the gateway. If you have multiple gateway serial numbers, click the "Add" button above the serial number field to add more.
- Provide a name for the site and enter its accurate coordinates to receive precise weather data on the following page
- On the last page of the site creator, provide any additional information that you deem necessary and then click the "Create Site" button to create the site.

The image shows three sequential screenshots of the NEP website's site creator form. The first screenshot shows a form with fields for 'User Email', 'Installer Email', 'Country Name' (a dropdown menu), 'State / Province' (a dropdown menu), 'City', and 'Street'. Below these is a section for 'SN/Address' with radio buttons for 'Gateway' (selected) and 'BDM-WIFI', and a 'Gateway S/N' field with 'Add' and 'Remove' buttons. A 'Next' button is at the bottom. The second screenshot shows the 'Name of Your Plant' field, 'Latitude' (dropdown for 'N' and input '47.6117986'), 'Longitude' (dropdown for 'W' and input '122.3022903'), and 'Timezone' (dropdown for '(GMT-07:00) America, Los Angeles'). 'Previous' and 'Next' buttons are at the bottom. The third screenshot shows 'Temperature Unit' (dropdown for 'Fahrenheit'), 'Power of Plant (kW)' (input '0'), 'Currency Unit' (dropdown for 'JPY' and input '1 kW'), 'Module Manufacture & Type' (input field), 'Location' (input field), and 'Upload Image of Your Plant' (with a 'Select image' button). An 'Other Viewer' field is at the bottom, with 'Previous' and 'Create' buttons.

5.7 Verify and Map Site

- Once you have confirmed the creation of the site on the NEP website, navigate to your dashboard where you should be able to see it.
- Click on the site to access its information and then click on "Open Viewer." The site's production data should now be visible on the first page. Note that it may take up to two hours for the gateway and inverters to fully register with the website.
- To access the module view, click on the dial. Here, you should see each microinverter listed. If you cannot see them, verify that the microinverters are listed on the device's ComID menu or allow more time for them to register.
- You can customize the site layout by navigating to Layout > Manage Layout. From here, you can drag modules as needed and change their orientation. You can also add different zones for various roofs or sections of the same roof from the Layout tab.

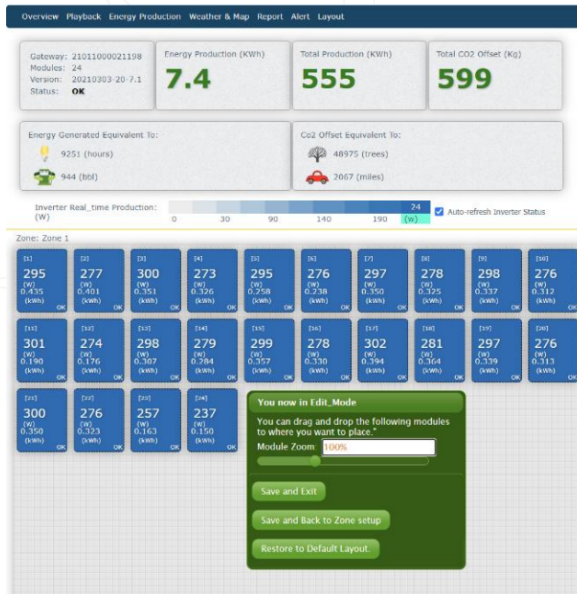

5.8 Commission the Gateway and Confirm Site Setup

- Contact NEP Support by emailing support@northernep.com or calling (888) 598-9901 to schedule a commissioning appointment for the gateway and to confirm that the site was set up correctly.

5.9 Grant Homeowner Access to Module View (Optional)

- Note that homeowners do not have access to the module view by default. If you would like to grant them access, please contact NEP Support via email at support@northernep.com or call (888) 598-9901.

6. Operating Instructions

When DC voltage from the module is applied, the BDM-600x is powered on automatically. Once sufficient DC power is applied, the status LED will begin to flash, indicating that the BDM-600x is live.

6.1 Status: Standby

- The LED light will turn on for 2 seconds and then turn off for 2 seconds.
- Red: Indicates an error is present.
- Orange: Indicates that the microinverter is not currently communicating with the BDG-256 but is functioning properly.
- Green: Indicates that the microinverter is functioning properly and communicating with the BDG-256

6.2 Producing Power

- The LED light will turn on for 1 seconds and then turn off for 1 seconds.
- Orange: Indicates that the microinverter is not currently communicating with the BDG-256 but is functioning properly.
- Green: Indicates that the microinverter is functioning properly and communicating with the BDG-256

6.3 Grounding Fault

- The LED Light is Solid Red
- The BDM-600x microinverter has multiple protective functions and will stop output power in the event of a fault. The fault message can be transmitted to a connected BDG-256 gateway via power line communication, and the gateway will display an error message in the form of a 16-bit error code.

Error code	Error
Bit-0	DC over voltage
Bit-1	DC under voltage
Bit-2	hardware error
Bit-3	Inverter over voltage
Bit-4	Frequency over
Bit-5	Frequency under
Bit-6	AC voltage RMS over
Bit-7	AC voltage RMS under
Bit-8	Peak AC voltage over
Bit-9	AC current RMS over
Bit-10	Peak AC current over
Bit-11	Temperature over
Bit-12	ADC error
Bit-13	GFDI fault indicator
Bit-14	Relay fault (BDM-250-AU/BDM-250-EU only)
Bit-15	PLC Communication Error



7. TROUBLESHOOTING AND MAINTENANCE

WARNING: DO NOT ATTEMPT TO REPAIR THE BDM-600x; IT CONTAINS NO USER-SERVICEABLE PARTS. IF TROUBLESHOOTING METHODS FAIL, PLEASE RETURN THE BDM-600x/400 TO YOUR DISTRIBUTOR FOR MAINTENANCE.

WARNING: NEVER DISCONNECT THE DC WIRE CONNECTORS UNDER LOAD. ENSURE THAT NO CURRENT IS FLOWING IN THE DC WIRES PRIOR TO DISCONNECTING. AN OPAQUE COVERING MAY BE USED TO COVER THE MODULE PRIOR TO DISCONNECTING

WARNING: ALWAYS DISCONNECT AC POWER BEFORE DISCONNECTING PV MODULE WIRES FROM BDM-600x/400. THE AC CONNECTOR OF THE FIRST BDM-600x/400 IN A BRANCH CIRCUIT IS SUITABLE AS A DISCONNECTING MEANS ONCE THE AC BRANCH CIRCUIT BREAKER IN THE LOAD CENTER HAS BEEN OPENED.

WARNING: BDM-600x/400 IS POWERED BY DC POWER FROM PV MODULES. MAKE SURE YOU DISCONNECT THE DC CONNECTIONS AND RECONNECT DC POWER TO WATCH FOR THE TWO SECONDS LED ON AND TWO SECONDS LED OFF AFTER DC IS APPLIED.

7.1 LED Indication of Error

7.1.A Error Mode (except for grounding error)

- The LED Light Flashes Red

7.1.B NOT communicating with BDG-256, and with no error

- The LED Light Flashed Orange

7.1.C Grounding Fault

- The LED Light is Solid Red

7.2 Troubleshooting An Inoperable BDM-600x/400

To troubleshoot an inoperable BDM-600x/400, follow the steps in the order shown:

- Check the connection to the utility grid and verify that the utility voltage and frequency are within the allowable ranges shown on the BDM-600x/400 label.
- Verify that utility power is present at the inverter in question by removing AC and DC power, then reconnecting the DC module connectors and watching for LED blinks. Never disconnect the DC wires while the BDM-600x/400 is producing power.
- Check the AC branch circuit interconnection harness between all BDM-600x/400s and verify that each inverter is energized by the utility grid as described in the previous step.
- Ensure that any AC disconnects are functioning properly and are closed.
- Verify that the PV module DC voltage is within the allowable range shown on the BDM-600x/400 label.
- Check the DC connections between the BDM-600x and the PV module.
- The PLC signal quality may be checked through the interface on the BDG-256 gateway. If the PLC signal is weak, it may be due to the distance between the microinverters and the gateway.



(888) 598-9901
info@northernep.com
www.northernep.com

7.3 Disconnecting a BDM-600x from the PV Module

To safely disconnect the BDM-600x from the PV modules, follow these steps in order:

- Turn off the AC power by opening the branch circuit breaker.
- Disconnect the first AC connector in the branch circuit.
- Cover the module with an opaque cover to block sunlight.
- Using a DC current probe, verify that there is no current flowing in the DC wires between the PV module and the BDM-600x.
- Note that DC clamp-on meters should be zeroed first and may drift with time.
- Disconnect the PV module DC wire connectors from the BDM-600x.
- Carefully remove the BDM-600x from the PV array racking.

7.4 Installing a Replacement BDM-600x

- Securely mount the replacement BDM-600x on the PV module racking using the recommended hardware from your racking vendor.
- Connect the AC cable of the replacement BDM-600x to the neighboring BDM-600x to complete the branch circuit connections.
- Complete the connection map and connect the PV modules.
 1. Ensure the connection map is complete.
 2. Each BDM-600x has a removable serial number located on the mounting plate. Input this serial number into a BDG-256 gateway and correspond it to a number in the connection map.
 3. Connect the PV modules to the BDM-600x.
- Install all BDM-600x and inter-wiring connections before installing the PV modules.
 1. Install all BDM-600x and inter-wiring connections before installing the PV modules.
 2. Connect the positive DC wire from the PV module to the negatively marked DC connector (male pin) of the BDM-600x. Then connect the negative DC wire from the PV module to the positively marked DC connector (female socket) of the BDM-600x. Repeat for all remaining PV modules using one BDM-600x for each module.
- Replace the old PLC_ID in the BDG-256 gateway with the new PLC_ID of the replacement BDM-600x.

8. Data Sheets

INPUT(DC)	Recommended Max PV Power (Wp)	450 x 2		
	Max DC Open Circuit Voltage (Vdc)	60		
	Max DC Input Current (Adc)	14 x 2		
	MPPT Tracking Accuracy	>99.5%		
	MPPT Tracking Range (Vdc)	22-55		
	Isc PV (absolute maximum) (Adc)	18 x 2		
	Maximum Inverter Backfeed Current to the Array (Adc)	0		
OUTPUT (AC)	Peak AC Output Power (Wp)	580 (continuous)		
	Rated AC Output Power (Wp)	500		
	Nominal Power Grid Voltage (Vac)	240	208	230
	Allowable Power Grid Voltage (Vac)	211-264*	183-229*	configurable*
	Allowable Power Grid Frequency (Hz)	59.3 a 60.5*		configurable*
	THD	<3% (at rated power)		
	Power Factor (cos phi, fixed)	>0.99 (at rated power)		
	Rated Output Current (Aac)	2.28	2.78	2.52
	Current (inrush)(Peak and Duration)	24A, 15us		
	Nominal Frequency (Hz)	60	50	
	Maximum Output Fault Current (Aac)	4.4A peak		
	Maximum Output Overcurrent Protection (Aac)	10		
	Maximum Number of Units Per Branch (20A) (All NEC adjustment factors have been considered)	7	6	6
	SYSTEM EFFICIENCY	Weighted Averaged Efficiency (CEC)	95.50%	
Night Time Tare Loss (Wp)		0.11		
PROTECTION FUNCTIONS	Over/Under Voltage Protection	Yes		
	Over/Under Frequency Protection	Yes		
	Anti-Islanding Protection	Yes		
	Over Current Protection	Yes		
	Reverse DC Polarity Protection	Yes		
	Overload Protection	Yes		
	Protection Degree	NEMA-6 / IP-66 / IP-67		
	Ambient Temperature	-40°F to +149°F (-40°C to +65°C)		
	Operating Temperature	-40°F to +185°F (-40°C to +85°C)		
	Display	LED LIGHT		
	Communications	Power Line		
	Dimension (W-H-D)	10.91"x5.20"x1.97"(277x132x50 mm)		
	Weight	6.4 lbs. (2.9 kg)		
	Environment Category	Indoor and outdoor		
	Wet Location	Suitable		
	Pollution Degree	PD 3		
	Overvoltage Category	II(PV), III (AC MAINS)		
	Product Safety Compliance	UL 1741 CSA C22.2 No. 107.1	IEC/EN 62109-1 IEC/EN 62109-2	
	Grid Code Compliance* (Refer to the label for the detailed grid code compliance)	IEEE 1547	VDE-AR-N 4105* VDE V 0126-1-1/A1 G83/2, CEI 021 AS 4777.2 & AS 4777.3, EN50438 ABNT NBR 16149/1615	



(888) 598-9901
info@northernep.com
www.northernep.com

9. WARRANTY AND PRODUCTION INFORMATION

What does this warranty cover and how long does it last?

This Limited Warranty is provided by Northern Electric & Power Co. Ltd (NEP) and covers defects in workmanship and materials in your ----- . This Warranty Period lasts for 1 year from the date of purchase at the authorized point of sale to you, the original end user customer, unless otherwise agreed in writing. You will be required to demonstrate proof of purchase to make warranty claims.

This Limited Warranty is transferable to subsequent owners but only for the unexpired portion of the Warranty Period. Subsequent owners also require original proof of purchase as described in "What proof of purchase is required?"

What will NEP do?

During the Warranty Period, NEP will, at its option, repair the product (if economically feasible) or replace the defective product free of charge, provided that you notify NEP of the product defect within the Warranty Period, and provided that NEP through inspection establishes the existence of such a defect and that it is covered by this Limited Warranty.

NEP will, at its option, use new and/or reconditioned parts in performing warranty repair and building replacement products. NEP reserves the right to use parts or products of original or improved design in the repair or replacement. NEP repairs or replaces a product, its warranty continues for the remaining portion of the original Warranty Period or 90 days from the date of the return shipment to the customer, whichever is greater. All replaced products and all parts removed from repaired products become the property of NEP.

How do you get service?

If your product requires troubleshooting or warranty service, contact your merchant. If you are unable to contact your merchant, or the merchant is unable to provide service, contact NEP directly at:

Northern Electric & Power Inc



Email: support@northernep.com

What does this warranty not cover?

Claims are limited to repair and replacement or if in NEP's discretion that is not possible, reimbursement up to the purchase price paid for the product. NEP will be liable to you only for direct damages suffered by you and only up to a maximum amount equal to the purchase price of the product.

This Limited Warranty does not warrant uninterrupted or error-free operation of the product or cover normal wear and tear of the product or costs related to the removal, installation, or troubleshooting of the customer's electrical systems. This warranty does not apply to and NEP will not be responsible for any defect in or damage to: a) the product if it has



 (888) 598-9901
 info@northernep.com
 www.northernep.com

been misused, neglected, improperly installed, physically damaged or altered, either internally or externally, or damaged from improper use or use in an unsuitable environment; b) the product if it has been subjected to fire, water, generalized corrosion, biological infestations, or input voltage that creates operating conditions beyond the maximum or minimum limits listed in the NEP product specifications including high input voltage from generators and

lightning strikes; c) the product if repairs have been done to it other than by NEP or its authorized service centers (hereafter "ASCs"); d) the product if it is used as a component part of a product expressly warranted by another manufacturer; e) the product if its original identification (trade-mark, serial number) markings have been defaced, altered, or removed; f) the product if it is located outside of the country where it was purchased; and g) any consequential losses that are attributable to the product losing power whether by product malfunction, installation error or misuse.

Disclaimer Product

THIS LIMITED WARRANTY IS THE SOLE AND EXCLUSIVE WARRANTY PROVIDED BY NEP IN CONNECTION WITH YOUR NEP PRODUCT AND IS, WHERE PERMITTED BY LAW, IN LIEU OF ALL OTHER WARRANTIES, CONDITIONS, GUARANTEES, REPRESENTATIONS, OBLIGATIONS AND LIABILITIES, EXPRESS OR IMPLIED, STATUTORY OR OTHERWISE IN CONNECTION WITH THE PRODUCT, HOWEVER ARISING (WHETHER BY CONTRACT, TORT, NEGLIGENCE, PRINCIPLES OF MANUFACTURER'S LIABILITY, OPERATION OF LAW, CONDUCT, STATEMENT OR OTHERWISE), INCLUDING WITHOUT RESTRICTION ANY IMPLIED WARRANTY OR CONDITION OF QUALITY, MERCHANTABILITY OR FITNESS FOR A PARTICULAR PURPOSE. ANY IMPLIED WARRANTY OF MERCHANTABILITY OR FITNESS FOR A PARTICULAR PURPOSE TO THE EXTENT REQUIRED UNDER APPLICABLE LAW TO APPLY TO THE PRODUCT SHALL BE LIMITED IN DURATION TO THE PERIOD STIPULATED UNDER THIS LIMITED WARRANTY.

IN NO EVENT WILL NEP BE LIABLE FOR: (a) ANY SPECIAL, INDIRECT, INCIDENTAL OR CONSEQUENTIAL DAMAGES, INCLUDING LOST PROFITS, LOST REVENUES, FAILURE TO REALIZE EXPECTED SAVINGS, OR OTHER COMMERCIAL OR ECONOMIC LOSSES OF ANY KIND, EVEN IF NEP HAS BEEN ADVISED, OR HAD REASON TO KNOW, OF THE POSSIBILITY OF SUCH DAMAGE, (b) ANY LIABILITY ARISING IN TORT, WHETHER OR NOT ARISING OUT OF NEP'S NEGLIGENCE, AND ALL LOSSES OR DAMAGES TO ANY PROPERTY OR FOR ANY PERSONAL INJURY OR ECONOMIC LOSS OR DAMAGE CAUSED BY THE

CONNECTION OF A PRODUCT TO ANY OTHER DEVICE OR SYSTEM, AND (c) ANY DAMAGE OR INJURY ARISING FROM OR AS A RESULT OF MISUSE OR ABUSE, OR THE INCORRECT INSTALLATION, INTEGRATION OR OPERATION OF THE PRODUCT.

IF YOU ARE A CONSUMER (RATHER THAN A PURCHASER OF THE PRODUCT IN THE COURSE OF A BUSINESS) AND PURCHASED THE PRODUCT IN A MEMBER STATE OF THE EUROPEAN UNION, THIS LIMITED WARRANTY SHALL BE SUBJECT TO YOUR STATUTORY RIGHTS AS A CONSUMER UNDER THE EUROPEAN UNION PRODUCT WARRANTY DIRECTIVE 1999/44/EC AND AS SUCH DIRECTIVE HAS BEEN IMPLEMENTED IN THE EUROPEAN UNION MEMBER STATE WHERE YOU PURCHASED THE PRODUCT. FURTHER, WHILE THIS LIMITED WARRANTY GIVES YOU SPECIFIC LEGAL RIGHTS, YOU MAY HAVE OTHER RIGHTS WHICH MAY VARY FROM EU MEMBERSTATE TO EU MEMBERSTATE OR, IF YOU DID NOT PURCHASE THE PRODUCT IN AN EU MEMBER STATE, IN THE COUNTRY YOU PURCHASED THE PRODUCT WHICH MAY VARY FROM COUNTRY TO COUNTRY AND JURISDICTION TO JURISDICTION